

PARTS LIST

Driver's all-season mat

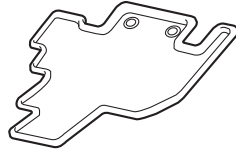

Passenger's all-season mat

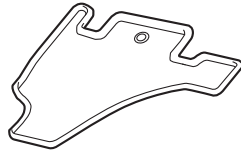

Second row all-season mat

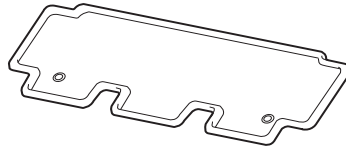

Third row all-season mat

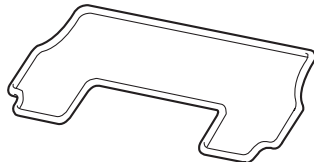
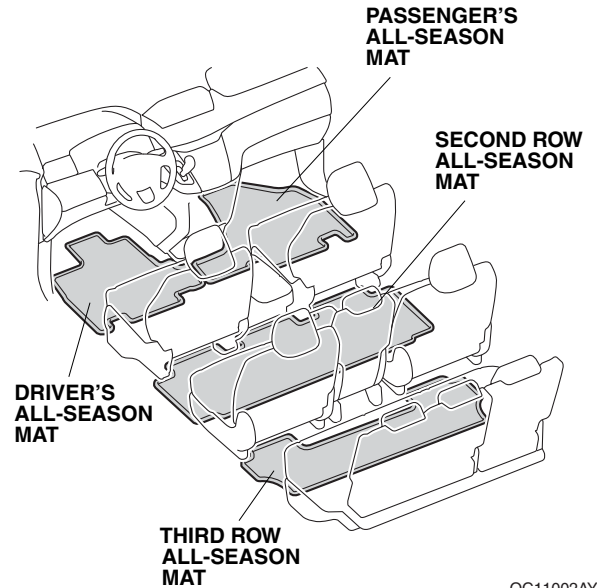
**Illustration of the All-Season Mats Installed on the Vehicle**

QC11002AY

INSTALLATION

Customer Information: The information in this installation instruction is intended for use only by skilled technicians who have the proper tools, equipment, and training to correctly and safely add equipment to your vehicle. These procedures should not be attempted by "do-it-yourselfers."

NOTE:

- Before installing the all-season mats, check the installation positions.
- Holders are required to prevent the mats from sliding forward and possibly interfering with the pedals.
- When replacing the all-season mats, use all-season mats that are compatible with the holders.
- Do not place additional mats on top of the all-season mats. The additional mats may slide forward and possibly interfere with the pedals.
- Make sure to re-anchor the mats after removing the all-season mats.

Installing the All-Season Mats

1. Remove the standard floor mats according to the vehicle owner's manual.

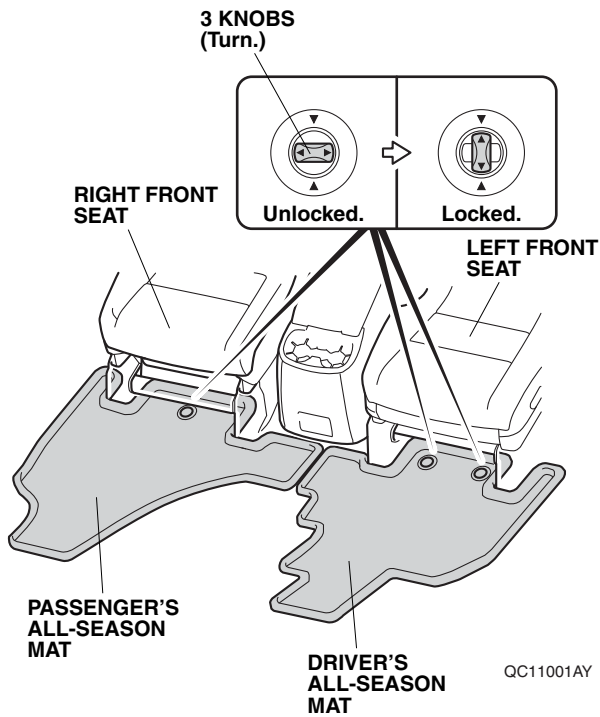

2. Install the driver's all-season mat over the two knobs on the floor.
3. Install the passenger's all-season mat over the one knob on the floor.
4. Turn the knob on each holder to secure the front all-season mat as shown.

5. Align and position the second row all-season mat to two knobs on the floor.

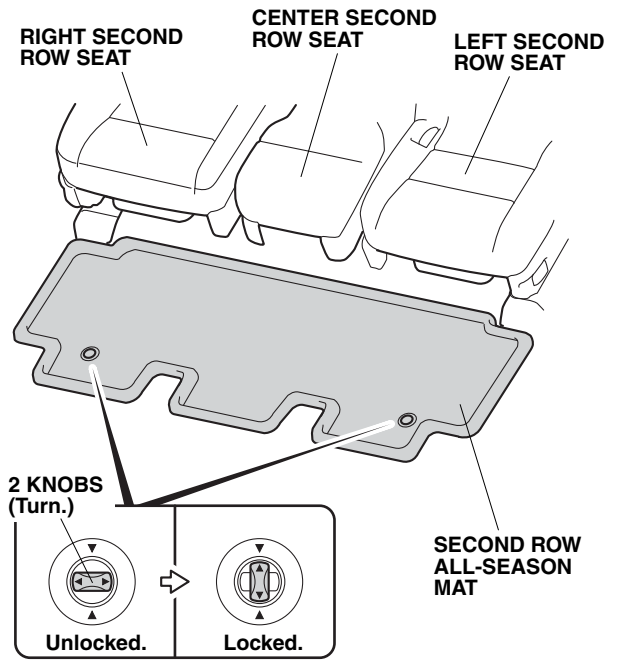

6. Turn the knob on each holder to secure the second row all-season mat as shown.
7. Position the third row all-season mat to the floor as shown.

