



INSTALLATION INSTRUCTIONS

Accessory
DOOR VISORS
P/N 08R04-T0A-100

Application
2016 CR-V

Publications No.
VERSION 1
Issue Date
SEP 2015

PARTS LIST

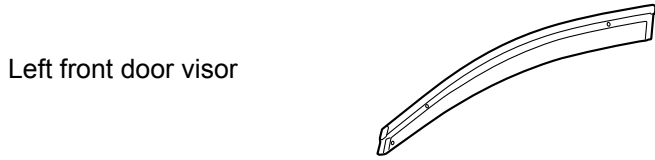

TOOLS AND SUPPLIES REQUIRED

- Isopropyl alcohol
- Shop towel
- Masking tape
- Ruler

Illustration of the Door Visors Installed on the Vehicle

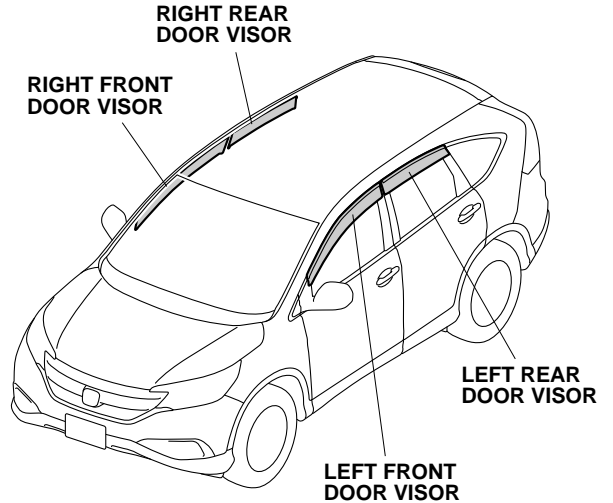

INSTALLATION

Customer Information: The information in this installation instruction is intended for use only by skilled technicians who have the proper tools, equipment, and training to correctly and safely add equipment to your vehicle. These procedures should not be attempted by “do-it-yourselfers.”

NOTE:

- Door visors may not be legal in all states. Please check the laws in your state.
- These instructions show the left door visors being installed. The same procedure applies to installing the right door visors.
- Be careful not to damage the body paint finish or the glass run channels when installing the door visors.
- Handle the door visors with care. They are not designed to absorb shock or impact.
- This kit should only be installed if the ambient air temperature is 15°C (60°F) or above.
- To allow the adhesive to cure, do not wash the vehicle for 24 hours. Please advise your customer.

Installing the Front Door Visor

1. Install one bracket B to the left front door visor with one clip as shown. Be sure the bracket is installed properly, once the clip is installed it cannot be removed.

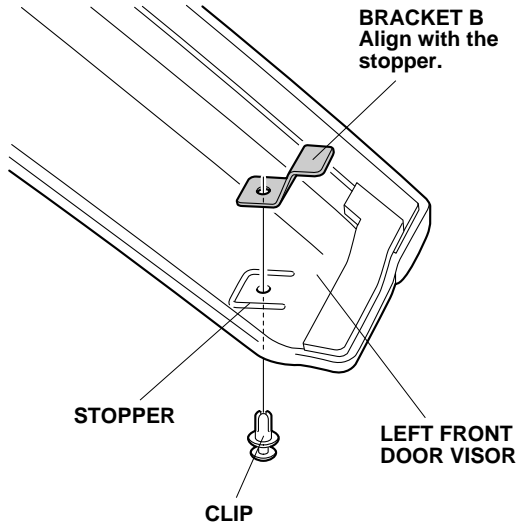

2. Fully open the left front door glass. Pull down the door glass run channel in the areas shown.

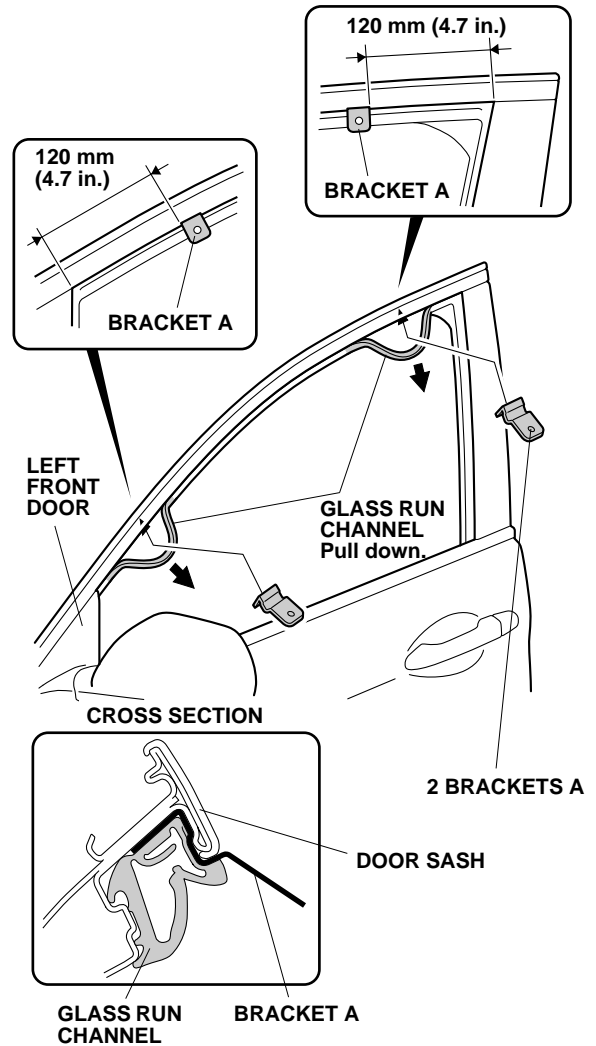

3. Install two brackets A between the door sash and the glass run channel at the measurements shown. Seat the glass run channel properly around the brackets.

- Using isopropyl alcohol on a shop towel, thoroughly clean the door sash where the left front door visor will attach.

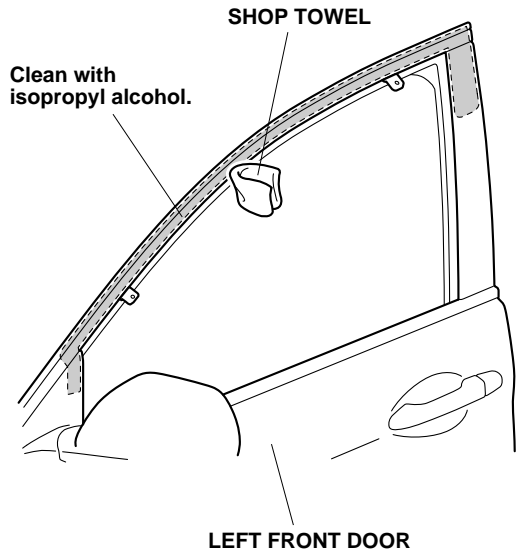

- Peel back approximately 1½ to 2 inches of adhesive backing from each adhesive tape, and tape the ends to the front surface of the left front door visor with masking tape.

2 ADHESIVE BACKINGS
Peel back 1½ to 2 inches of adhesive backing and tape it to the front of the door visor.

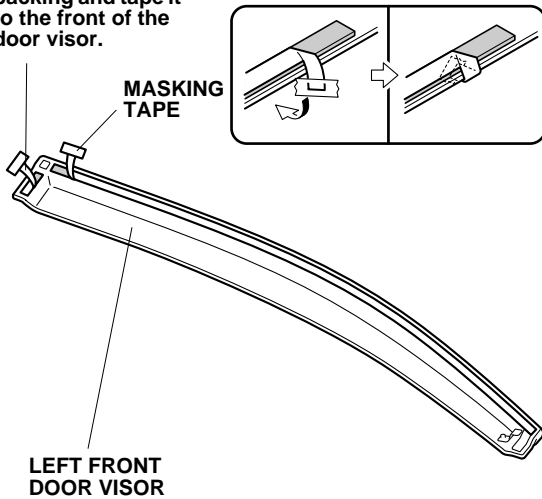

- Position the left front door visor onto the left front door by inserting bracket B between the door mirror base and glass run channel as shown.

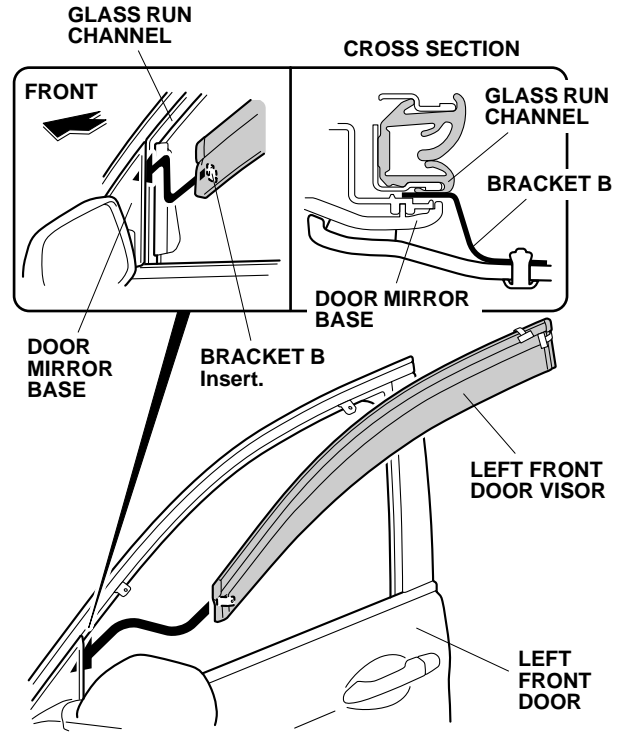

7. Align the clip holes in the left front door visor with the bracket holes, and install the clips while pushing up on each bracket A. There should be no clearance between the brackets and the door sash.
NOTE: Be sure the bracket and the door visor are aligned properly. Once the clip is installed, it cannot be reused.

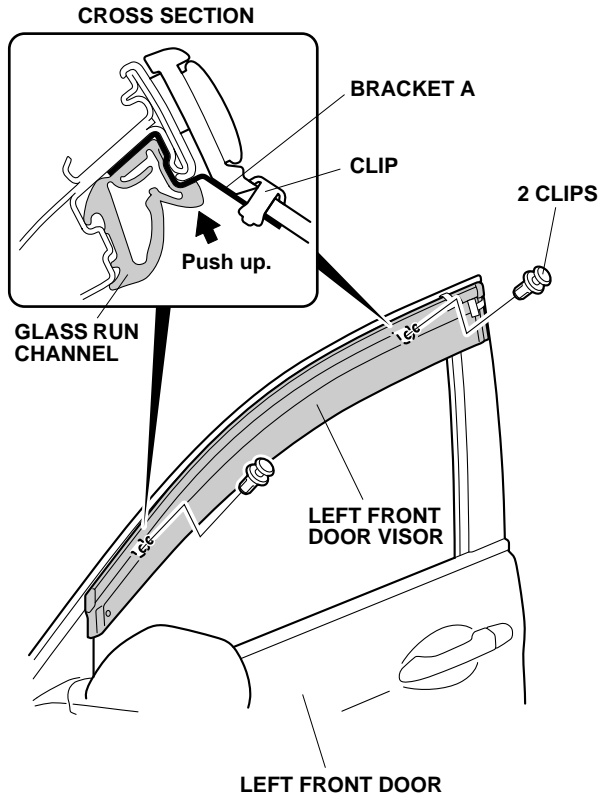

8. Adjust the end gap of the left front door visor as shown.

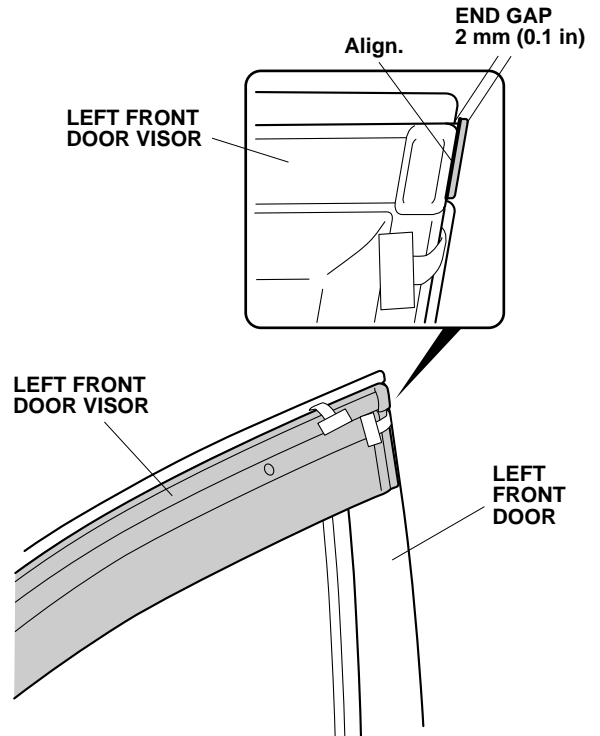

- While applying light pressure against the left front door visor, carefully remove the adhesive backings in the order shown. Use your finger to push up each bracket so there is no gap between the bracket and the door sash.

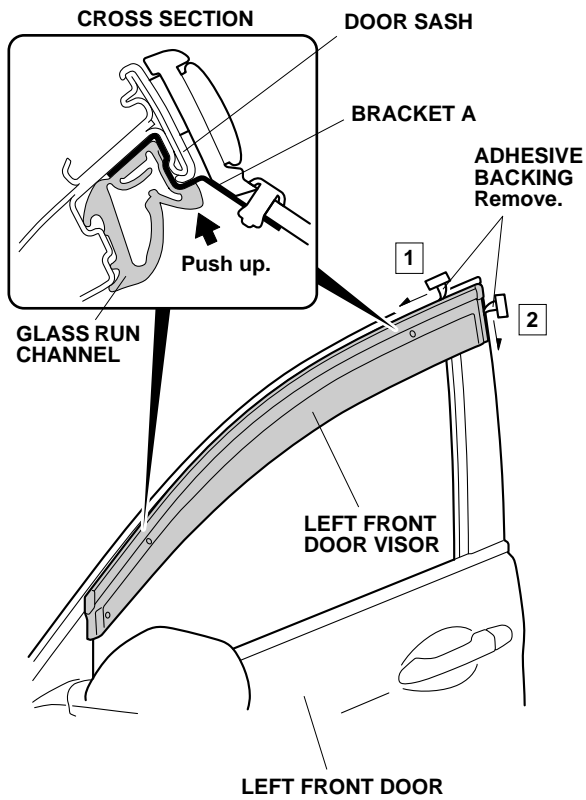

- Using a soft towel, press and hold the left front door visor against the door sash for 30 seconds.
- Repeat steps 1 through 10 to install the right front door visor on the right side of the vehicle.

Installing the Rear Door Visor

- Fully open the left rear door glass. Pull down the door glass run channel in the areas shown.

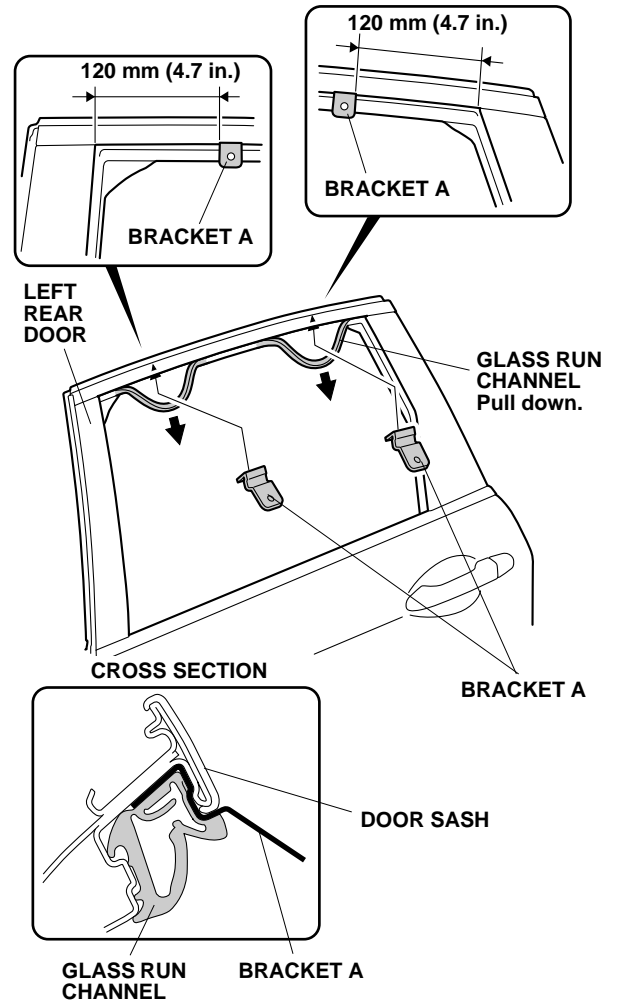

- Install two brackets A between the door sash and the glass run channel at the measurements shown. Seat the glass run channel properly around the brackets.

14. Using an isopropyl alcohol on a shop towel, thoroughly clean the door sash where the left rear door visor will attach.

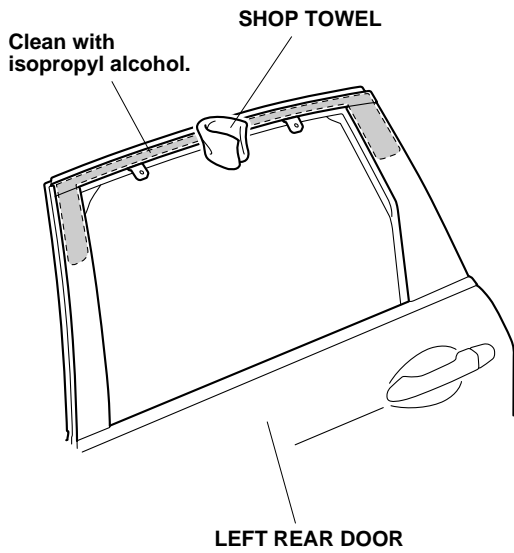

15. Peel back approximately 1½ to 2 inches of adhesive backing from each adhesive tape, and tape the ends to the front surface of the left rear door visor with masking tape.

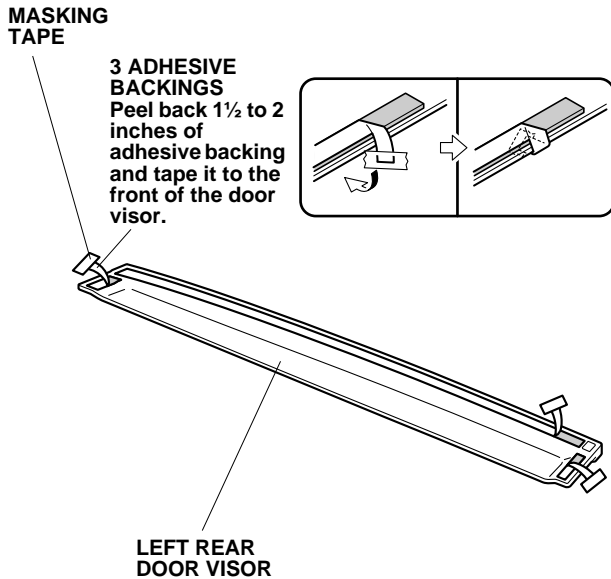

16. Align the clip holes in the left rear door visor with the bracket holes, and install the clips while pushing up on each bracket A. There should be no clearance between the brackets and the door sash.
NOTE: Be sure the bracket and the door visor are aligned properly. Once the clip is installed, it cannot be reused.

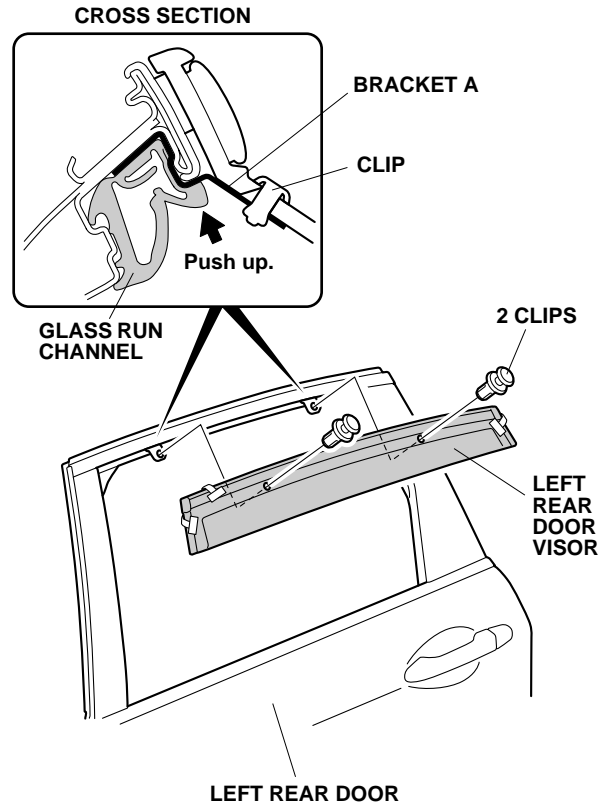

17. Adjust the end gap of the left rear door visor as shown.

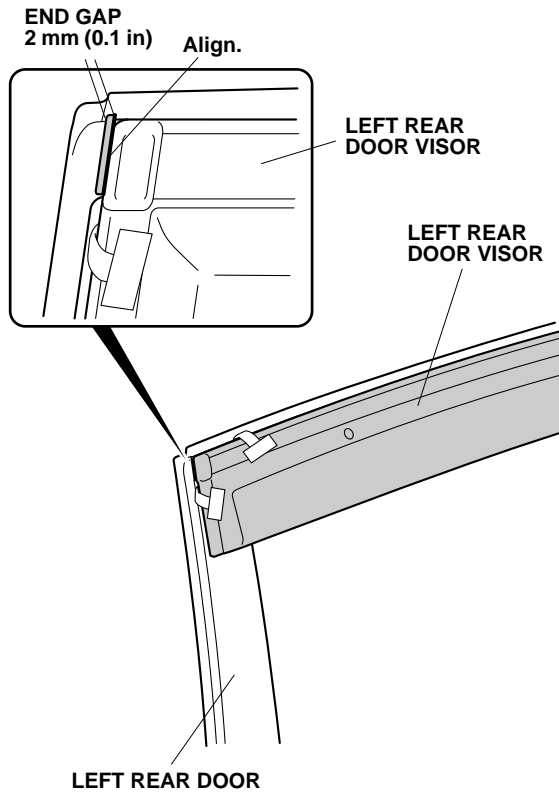

18. While applying light pressure against the left rear door visor, carefully remove the adhesive backings in the order shown. Use your fingers to push up each bracket so there is no gap between the brackets and the door sash.

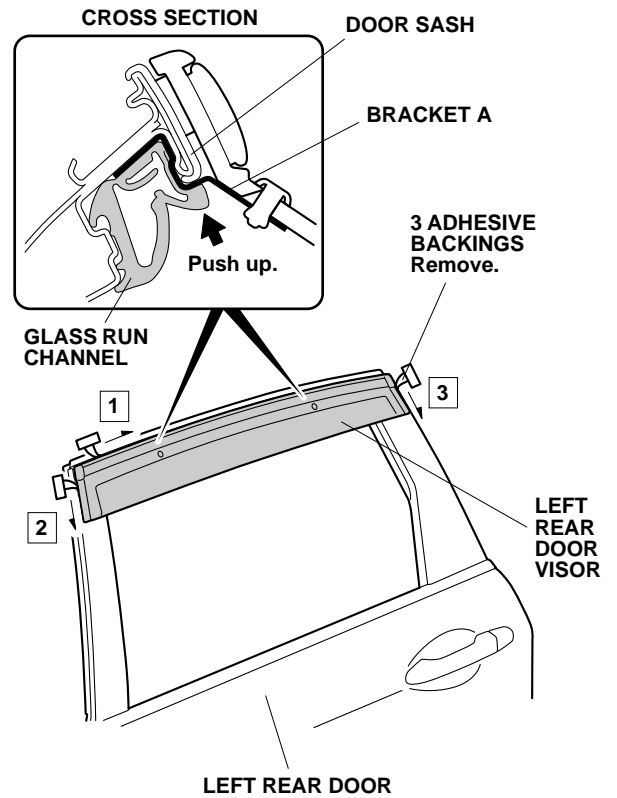

19. Using a soft towel, firmly press and hold the left rear door visor against the door sash for 30 seconds.
20. Repeat steps 12 through 19 on the right rear door visor on the right side of the vehicle.

USE AND CARE

Clean the door visors with mild detergent and water. Do not use organic solvents (thinners, benzine, alcohol, etc.) or cleaners containing any abrasive material.