



# INSTALLATION INSTRUCTIONS

Accessory  
**FLOOR MATS**

Application  
**2012 FIT**

Publications No.  
**All 45995**  
Issue Date  
**AUG 2011**

Put this information in the glove box with the vehicle owner's manual.

## PARTS LIST

Driver's side floor mat

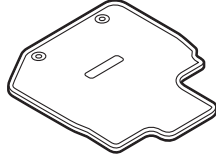

Passenger's side floor mat

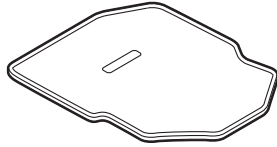

Left rear floor mat

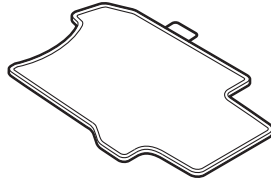

Right rear floor mat

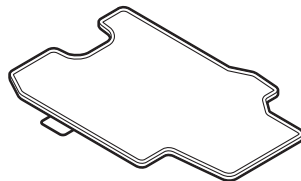

2 Anchors

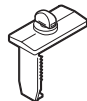

## INSTALLATION

### NOTE:

- Before installing the floor mats, identify their installation positions.
- Anchors are required for the driver's side of the vehicle; they prevent the floor mat from sliding forward and interfering with the pedals.
- If you remove the driver's side mat, make sure you reanchor it when you put it back in the vehicle.
- If you replace the floor mats, use factory mats designed to be used with the anchors.
- Do not put a floor mat on top of the anchored mat. The additional mat may slide forward and interfere with the pedals.

1. Place the driver's side floor mat over the anchors as shown.

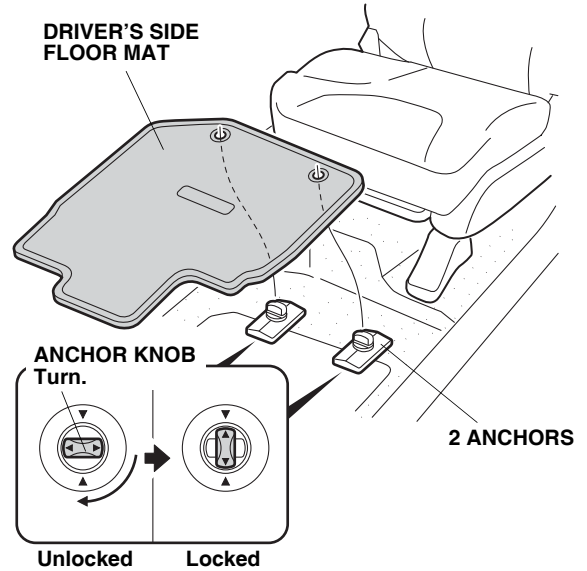

2. Turn the knobs on the anchors to secure the driver's side floor mat.
3. Install the passenger's side floor mat.

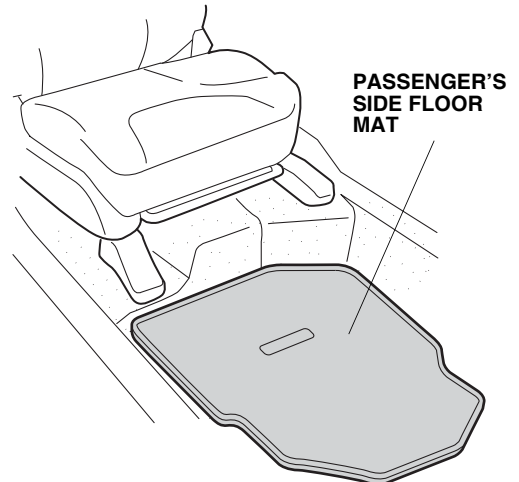

4. Install the right and left rear floor mats. Insert the tab from each floor mat under the sill trim.

