

PARTS LIST

Rear bumper applique

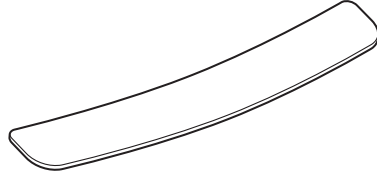

Applicator

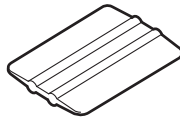

Soft sleeve

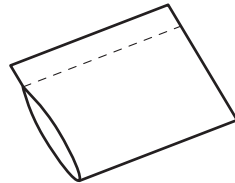

Alcohol swab

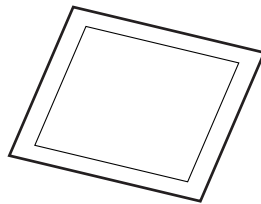
**TOOLS AND SUPPLIES REQUIRED**

Masking tape

Felt-tip pen

Ruler

INSTALLATION**NOTE:**

- Be careful not to damage the rear bumper and other finished surfaces of the body.
 - The rear bumper applique should be installed only if the ambient air temperature is 15°C (60°F) or above. Heat the rear bumper applique and bonding surfaces with a hair dryer set on LOW if the ambient air temperatures is below.
 - Do not wash the vehicle for 24 hours to cure the adhesive.
1. Using the alcohol swab, clean the rear bumper where the rear bumper applique will attach.

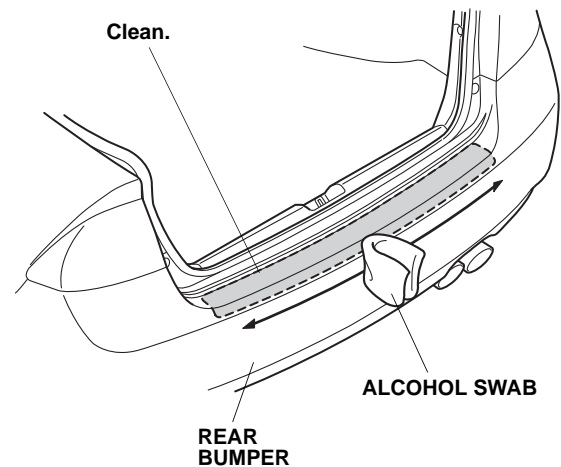

2. Attach masking tape to the rear bumper applique, then mark on the masking tape as shown.

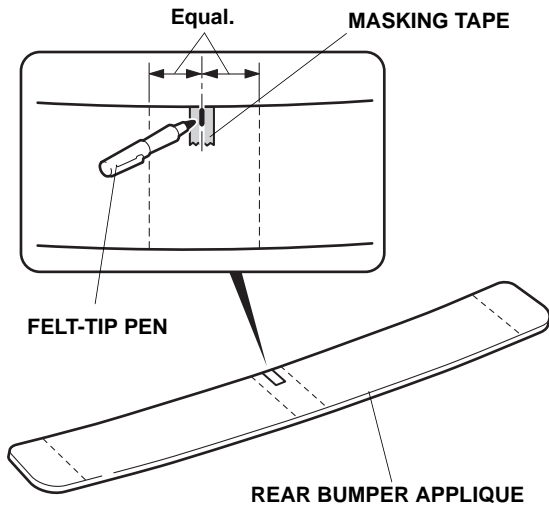

3. Place the rear bumper applique on the rear bumper, then attach masking tape to the rear bumper as shown.

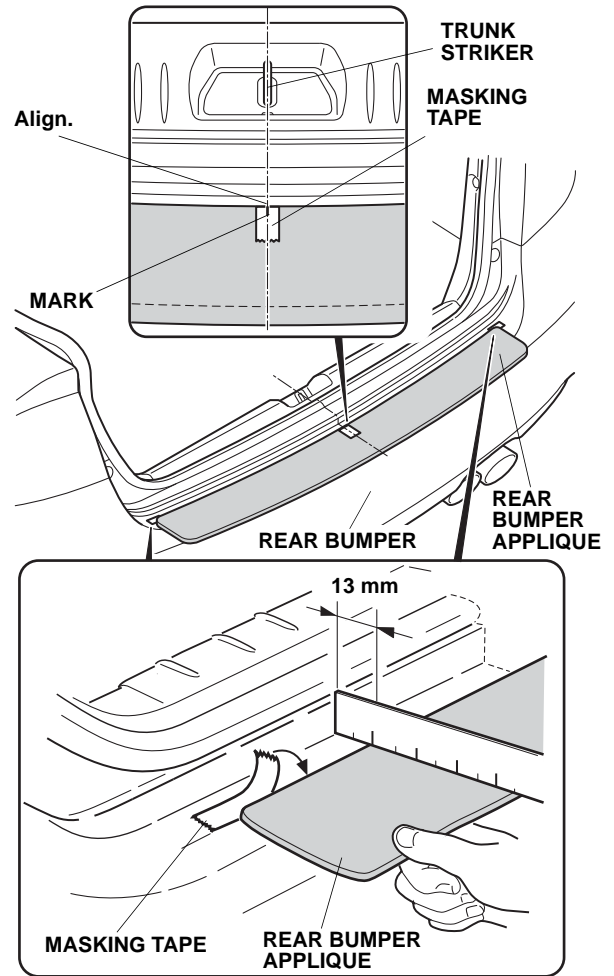

- Remove the center backing from the rear bumper applique.

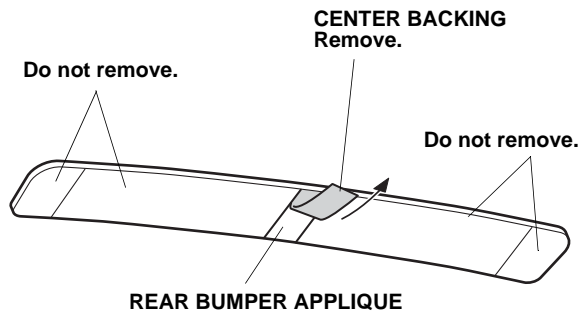

- Place the rear bumper applique on the rear bumper as shown.

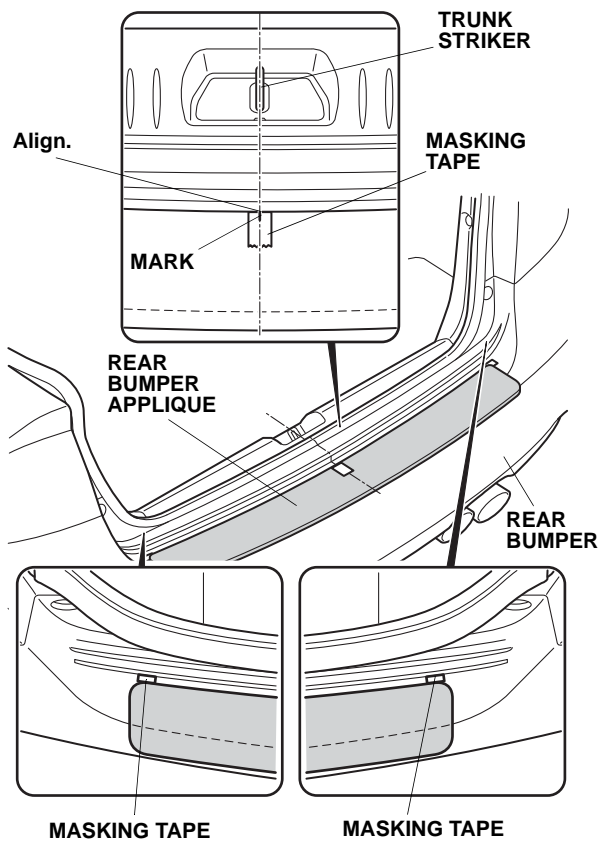

- Remove the backing shown. Using the applicator with soft sleeve, apply pressure to smooth out the top surface of the rear bumper applique. If you see any air bubbles, gently peel up that section and work out the air bubbles.

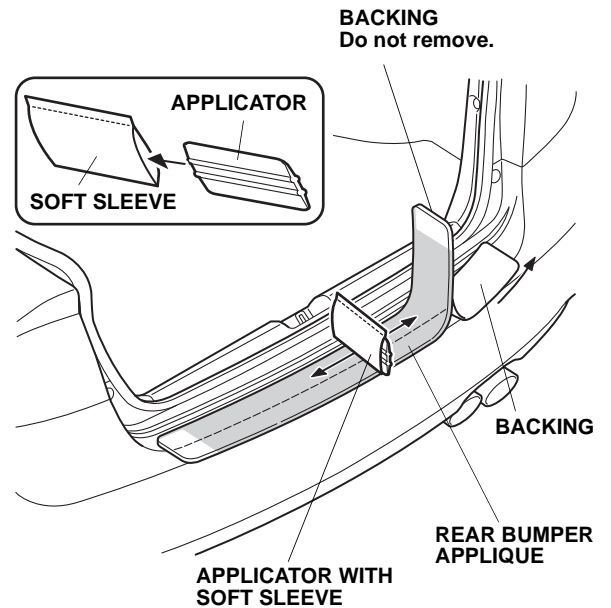

- Smooth out the other side in the same way.
- Remove the backing shown. Using the applicator with soft sleeve, apply pressure to smooth out the top surface the rear bumper applique. If you see any air bubbles, gently peel up that section and work out the air bubbles.

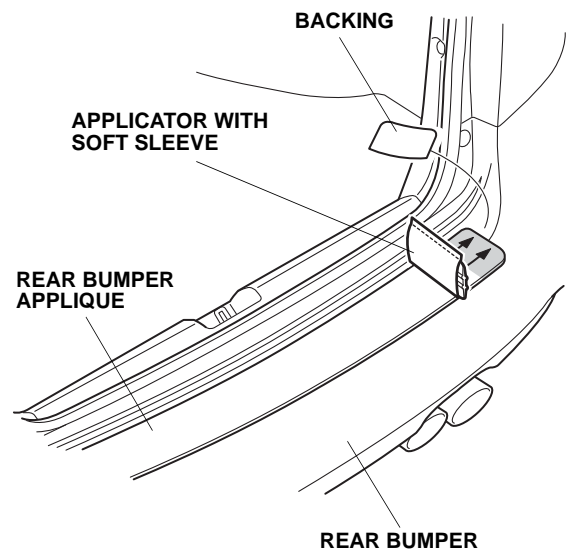

- Smooth out the other side in the same way.

10. Starting from the middle and working outward, use the applicator with soft sleeve to apply the rear bumper applique to the rounded rear edge as shown.

